

**EL ALETLERİ
GRUBU ve ATÖLYE
EKİPMANLARI**



0320

Kombine Anahtar Kısa Boy (mm)
Combination Wrench
Short Pattern (mm)

TS 3794 • DIN 3113

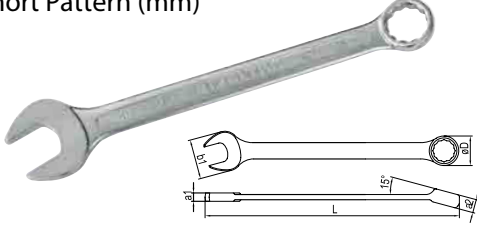

Krom vanadyum, Krom kaplı
Chrom vanadium, Chrom plated

KOD CODE	Ø mm	L mm	a1 mm	a2 mm	b1 mm	øD mm	g
0320 02 0005	5	100	3.4	5.1	14	10	15
0320 02 0055	5.5	100	3.4	5.1	14	10	15
0320 02 0006	6	100	3.4	5.1	14	10	15
0320 02 0007	7	110	3.6	5.5	16	11	20
0320 02 0008	8	120	3.8	5.9	18	13	25
0320 02 0009	9	130	4	6.3	20	14	30
0320 02 0010	10	140	4.3	6.9	22	15.5	40
0320 02 0011	11	150	4.5	7.3	24	17	45
0320 02 0012	12	160	4.9	7.7	26	18.5	55
0320 02 0013	13	170	5.2	7.9	28	19.5	60
0320 02 0014	14	180	5.5	8.7	30	21.5	75
0320 02 0015	15	190	5.8	9.1	32	22.5	90
0320 02 0016	16	200	6.1	9.6	34	24	105
0320 02 0017	17	210	6.4	9.8	36	25.5	120
0320 02 0018	18	220	6.8	10.4	38	27	145
0320 02 0019	19	232	7	11	40	28.5	170
0320 02 0020	20	240	7.2	11.4	42	30	195
0320 02 0021	21	250	7.4	12	44	31.5	190
0320 02 0022	22	260	8.2	12.6	46	33	275
0320 02 0023	23	270	8.3	13	48	35	255
0320 02 0024	24	280	8.5	13.6	50	36.5	320
0320 02 0025	25	290	8.8	14	52	39	320
0320 02 0026	26	300	9	14.8	54	41	400
0320 02 0027	27	310	9.3	15	56	41.5	400
0320 02 0028	28	320	9.4	15.4	57.5	42.5	380
0320 02 0029	29	330	10	15.6	59	43.5	510
0320 02 0030	30	340	10.3	16	61.5	44	505
0320 02 0032	32	370	10.5	16.2	65.5	47	560
0320 02 0034	34	400	10.7	16.8	71	50	675



0330

Kombine Anahtar Uzun Boy (mm)
Combination Wrench,
Long Pattern (mm)

TS 3794 • DIN 3113



Krom vanadyum, Krom kaplı
Chrom vanadium, Chrom plated

KOD CODE	Ø mm	L mm	a1 mm	a2 mm	b1 mm	øD mm	g
0330 02 0005	5	95	3.2	5.2	12.5	9	20
0330 02 0055	5.5	100	3.4	5.4	13.5	9.5	20
0330 02 0006	6	105	3.8	5.6	14	10.5	20
0330 02 0007	7	117	4	6.1	16	12	20
0330 02 0008	8	130	4.2	6.6	18	13.5	30
0330 02 0009	9	141	4.5	7	20	15	40
0330 02 0010	10	154	4.7	7.6	22	16	50
0330 02 0011	11	166	5	8.2	24	17.5	60
0330 02 0012	12	178	5.2	8.7	26	19	70
0330 02 0013	13	190	5.6	9.2	28	20.5	80
0330 02 0014	14	203	5.8	9.7	30	22	100
0330 02 0015	15	215	6.4	10.1	32	23.5	115
0330 02 0016	16	227	6.4	10.8	34	25	135
0330 02 0017	17	239	6.6	11.4	36	26.5	160
0330 02 0018	18	250	7	12	38	28	186
0330 02 0019	19	263	7.3	12.7	40	29.5	205
0330 02 0020	20	275	7.7	13.2	42	31	235
0330 02 0021	21	288	8.1	13.3	44	31.5	260
0330 02 0022	22	300	8.5	13.7	46	34	300
0330 02 0023	23	315	8.8	14.2	48	35.5	300
0330 02 0024	24	330	9	14.2	50	37	390
0330 02 0025	25	340	9.3	14.7	52	38.5	380
0330 02 0026	26	350	9.7	14.7	54	40	475
0330 02 0027	27	360	10	15.2	56	41	475
0330 02 0028	28	370	10.4	15.7	57.5	43	475
0330 02 0029	29	390	10.8	16.2	59	44	610
0330 02 0030	30	410	11.2	16.6	61.5	45	610
0330 02 0032	32	420	11.5	17.1	65.5	48	755
0330 02 0034	34	430	11.8	17.4	71	51	735
0330 02 0036	36	440	12.2	17.7	76	53	1000
0330 02 0038	38	450	12.5	18.7	80	56	1000
0330 02 0041	41	480	13.5	19.7	87	61	1240
0330 02 0046	46	505	14.7	20.7	95	67.5	1635
0330 02 0050	50	540	15.9	22.7	104	73.5	2100



0100

İki Ağız Anahtar Kısa Boy (mm)
Double Ended Open Jaw Wrench
Short Pattern (mm)



TS 81 • DIN 895

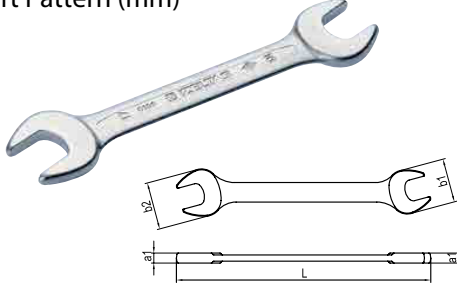

Krom vanadyum, Krom kaplı
Chrom vanadium, Chrom plated

KOD CODE	mm	L mm	a1 mm	b1 mm	b2 mm	g
0100 01 0405	4x5	97	3.5	11	12.5	15
0100 01 0607	6x7	97	3.5	14	16	18
0100 01 0809	8x9	108	4	18	20	30
0100 01 0810	8x10	117	4.6	18	22	33
0100 01 1011	10x11	120	4.6	22	24	41
0100 01 1012	10x12	120	4.6	22	26	35
0100 01 1013	10x13	120	4.6	22	28	38
0100 01 1114	11x14	133	5.2	26	28	50
0100 01 1213	12x13	133	5.2	26	28	57
0100 01 1214	12x14	147	5.2	26	30	59
0100 01 1314	13x14	147	5.2	28	30	66
0100 01 1415	14x15	147	5.8	30	32	78
0100 01 1317	13x17	162	6.2	28	36	80
0100 01 1417	14x17	162	6.2	30	36	90
0100 01 1617	16x17	162	6.2	34	36	109
0100 01 1719	17x19	178	7	36	40	143
0100 01 1819	18x19	178	7	38	40	144
0100 01 1820	18x20	178	7	38	40	125
0100 01 1822	18x22	195	7.4	38	46	160
0100 01 1922	19x22	195	7.4	40	46	175
0100 01 2022	20x22	195	7.4	42	46	196
0100 01 2123	21x23	213	7.7	44	48	230
0100 01 2224	22x24	213	8	46	50	239
0100 01 2426	24x26	232	8.2	50	54	297
0100 01 2427	24x27	232	8.2	50	56	296
0100 01 2528	25x28	248	8.6	52	57.5	366
0100 01 2732	27x32	265	9	56	66	415
0100 01 3032	30x32	265	9	62	66	465

0130

İki Ağız Anahtar Uzun Boy (mm)
Double Ended Open Jaw Wrench
Long Pattern (mm)



Krom vanadyum, Krom kaplı
Chrom vanadium, Chrom plated

KOD CODE	mm	L mm	a1 mm	b1 mm	b2 mm	g
0130 01 0607	6x7	125	3.5	14	16	24
0130 01 0608	6x8	125	3.5	14	18	20
0130 01 0809	8x9	140	4	18	20	35
0130 01 0810	8x10	140	4	18	22	36
0130 01 1011	10x11	155	4.5	22	24	47
0130 01 1012	10x12	162	4.7	22	26	57
0130 01 1013	10x13	162	4.7	22	28	61
0130 01 1014	10x14	162	4.7	22	28	65
0130 01 1113	11x13	172	5	26	28	70
0130 01 1114	11x14	172	5	26	30	65
0130 01 1213	12x13	172	5	26	28	67
0130 01 1214	12x14	172	5	26	30	65
0130 01 1314	13x14	188	5.5	28	30	85
0130 01 1315	13x15	188	5.5	30	32	93
0130 01 1415	14x15	188	5.5	30	32	91
0130 01 1317	13x17	205	6.2	28	36	111
0130 01 1417	14x17	205	6.2	30	36	106
0130 01 1617	16x17	205	6.2	34	36	120
0130 01 1618	16x18	220	7	36	40	165
0130 01 1719	17x19	220	7	36	40	160
0130 01 1819	18x19	220	7	38	40	161
0130 01 1921	19x21	235	7.5	40	46	195
0130 01 1922	19x22	235	7.5	40	46	195
0130 01 2022	20x22	235	7.5	42	46	195
0130 01 1924	19x24	248	8.3	40	50	235
0130 01 2123	21x23	248	8.3	44	48	235
0130 01 2224	22x24	248	8.3	46	50	235
0130 01 2426	24x26	265	8.8	50	54	300
0130 01 2427	24x27	265	8.8	50	56	300
0130 01 2430	24x30	282	9.3	50	61.5	380
0130 01 2528	25x28	282	9.3	52	57.5	390
0130 01 2729	27x29	300	9.8	56	59	400
0130 01 2730	27x30	300	9.8	56	59	440
0130 01 2732	27x32	300	9.8	56	65.5	460
0130 01 3032	30x32	300	9.8	61.5	65.5	480
0130 01 3036	30x36	325	10.4	61.5	76	645
0130 01 3236	32x36	325	10.4	65.5	76	680
0130 01 3436	34x36	330	10.4	71	76	690
0130 01 3641	36x41	360	12	76	87	955
0130 01 4146	41x46	400	12.5	87	98	1300
0130 01 4650	46x50	450	13	98	107	1635

0320

Kombine Anahtar Takımı Kısa Boy (mm) 
Combination Wrench Short Pattern Set (mm)



KOD CODE	İÇERİK CONTENTS	g
0320 00 2108	6 - 7 - 8 - 9 - 10 - 13 - 17 - 19	475
0320 00 2112	8 - 9 - 10 - 11 - 12 - 13 - 14 15 - 16 - 17 - 19 - 22	1190
0320 00 2117	6 - 7 - 8 - 9 - 10 - 11 - 12 - 13 - 14 15 - 16 - 17 - 18 - 19 - 20 - 21 - 22	1760
0320 00 2121	6 - 7 - 8 - 9 - 10 - 11 - 12 - 13 - 14 15 - 16 - 17 - 18 - 19 - 20 - 21 - 22 24 - 27 - 30 - 32	3650

0100

İki Ağız Anahtar Takımı Kısa Boy (mm) 
Double Ended Open Jaw Wrench
Short Pattern Set (mm)



KOD CODE	İÇERİK CONTENTS	g
0100 00 2108	6x7 - 8x9 - 10x11 12x13 - 14x15 - 16x17 18x19 - 20x22	736
0100 00 2112	6x7 - 8x9 - 10x11 12x13 - 14x15 - 16x17 18x19 - 20x22 - 21x23 24x26 - 25x28 - 30x32	2110

0330

Kombine Anahtar Takımı Uzun Boy (mm) 
Combination Wrench
Long Pattern Set (mm)



KOD CODE	İÇERİK CONTENTS	g
0330 00 2108	6 - 7 - 8 - 9 - 10 - 13 17 - 19	665
0330 00 2112	8 - 9 - 10 - 11 - 12 13 - 14 - 15 - 16 17 - 19 - 22	1780
0330 00 2117	6 - 7 - 8 - 9 - 10 11 - 12 - 13 - 14 - 15 16 - 17 - 18 - 19 20 - 21 - 22	2170
0330 00 2121	6 - 7 - 8 - 9 - 10 - 11 12 - 13 - 14 - 15 - 16 17 - 18 - 19 - 20 - 21 22 - 24 - 27 - 30 - 32	4465

0130

İki Ağız Anahtar Takımı Uzun Boy (mm) 
Double Ended Open Jaw Wrench
Long Pattern Set (mm)



KOD CODE	İÇERİK CONTENTS	g
0130 00 2108	6x7 - 8x9 - 10x11 - 12x13 14x15 - 16x17 - 18x19 20x22	815
0130 00 2112	6x7 - 8x9 - 10x11 12x13 - 14x15 - 16x17 18x19 - 20x22 - 21x23 24x26 - 25x28 - 27x32	2315

0430

Yıldız İki Ağız Anahtar (mm)
Double Ended Ring Wrench (mm)



TS 3794• DIN 838

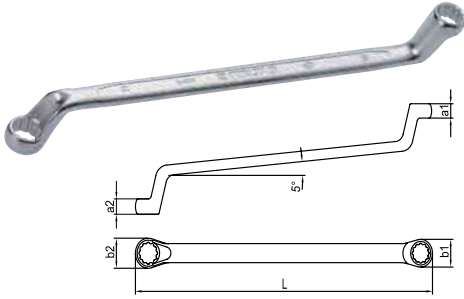

Krom vanadyum, Krom kaplı
Chrom vanadium, Chrom plated

KOD CODE	mm	L mm	a1 mm	a2 mm	b1 mm	b2 mm	g
0430 03 0607	6x7	176	5.6	6	10	11.5	55
0430 03 0809	8x9	190	6.4	6.8	13	14.5	75
0430 03 0810	8x10	190	6.4	7.3	13	15.5	70
0430 03 1011	10x11	206	7.3	7.6	15.5	17	105
0430 03 1012	10x12	206	7.3	8.5	15.5	18.5	105
0430 03 1013	10x13	220	7.3	9	15.5	20	120
0430 03 1113	11x13	220	7.6	9	17	20	130
0430 03 1213	12x13	220	8.5	9	18.5	20	135
0430 03 1214	12x14	220	8.5	9.5	18.5	21.5	145
0430 03 1415	14x15	236	9.5	10	21.5	23	180
0430 03 1317	13x17	250	9	11.5	20	26.5	215
0430 03 1417	14x17	250	9.5	11.5	21.5	26.5	210
0430 03 1617	16x17	250	10.8	11.5	25	26.5	220
0430 03 1618	16x18	250	10.8	12	25	27.5	210
0430 03 1719	17x19	271	11.5	12.5	26.5	29	270
0430 03 1819	18x19	271	12	12.5	27.5	29	270
0430 03 1922	19x22	291	12.5	13.5	29	33	330
0430 03 1924	19x24	311	12.5	14.2	29	36.5	345
0430 03 2022	20x22	291	12.9	13.5	30.5	33	330
0430 03 2123	21x23	311	13.1	14	32	35	410
0430 03 2224	22x24	321	13.5	14.2	33	36.5	410
0430 03 2426	24x26	331	14.2	14.6	36.5	39.5	495
0430 03 2427	24x27	331	14.2	15	36.5	40.5	495
0430 03 2430	24x30	352	14.2	16.7	36.5	40	530
0430 03 2528	25x28	352	14.5	15.5	38	42.5	550
0430 03 2729	27x29	371	15	16.7	40.5	45	660
0430 03 2730	27x30	371	15	16.7	40.5	45	660
0430 03 2732	27x32	371	15	16.7	40.5	47.5	660
0430 03 3032	30x32	371	16.4	16.7	45	47.5	660
0430 03 3036	30x36	402	16.4	17.5	45	53	880
0430 03 3236	32x36	402	16.7	17.5	47.5	53	890
0430 03 3436	34x36	420	17.1	17.5	50	53	1000
0430 03 3641	36x41	438	17.5	19.5	53	61	1150
0430 03 4146	41x46	485	19.5	20.5	61	67.5	1430
0430 03 4650	46x50	535	20.5	22.4	67.5	73.5	1960

0430

Yıldız İki Ağız Anahtar Takımı (mm)
Double Ended Ring Wrench Set (mm)



KOD CODE	İÇERİK CONTENTS	g
0430 00 2108	6x7 - 8x9 - 10x11 - 12x13 - 14x15 16x17 - 18x19 - 20x22	1450
0430 00 2112	6x7 - 8x9 - 10x11 - 12x13 - 14x15 16x17 - 18x19 - 20x22 - 21x23 24x26 - 25x28 - 27x32	3610

0600

Kurbağacık Anahtar
Adjustable Wrench

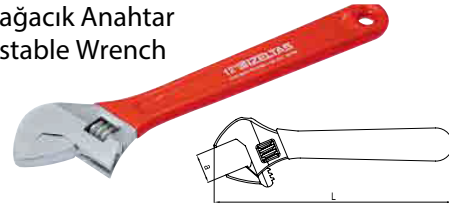

Krom vanadyum, Krom kaplı, PVC izoleli
Chrom vanadium, Chrom plated, PVC insulated

KOD CODE	L mm	L inch	a mm	g
0600 01 1006	160	6"	18	120
0600 01 1008	208	8"	23	230
0600 01 1010	260	10"	28	400
0600 01 1012	308	12"	34	670
0600 01 1015	388	15"	43	1555



0700

Çatal Çakma Anahtar (mm)
Slugging Open Jaw Wrench (mm)

TS 81 • DIN 133

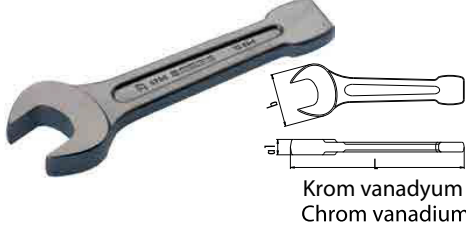

KOD CODE	mm	L mm	a1 mm	b mm	g
0700 05 0024	24	160	15	42	280
0700 05 0027	27	180	16	45	385
0700 05 0030	30	190	17	50	525
0700 05 0032	32	190	17	50	530
0700 05 0036	36	205	19	58	755
0700 05 0038	38	205	19	58	760
0700 05 0041	41	225	20	62	920
0700 05 0042	42	225	20	62	930
0700 05 0046	46	240	22	72	1305
0700 05 0047	47	240	22	72	1320
0700 05 0050	50	255	23	78	1565
0700 05 0055	55	272	25	88	2305
0700 05 0060	60	272	25	88	2310
0700 05 0065	65	300	28	98	3300
0700 05 0070	70	330	32	108	4555
0700 05 0075	75	330	32	108	4460
0700 05 0080	80	360	35	126	6115
0700 05 0085	85	360	35	126	5740
0700 05 0090	90	390	40	140	8040
0700 05 0095	95	390	40	140	8160
0700 05 0100	100	420	44	148	12355
0700 05 0105	105	420	44	148	11785
0700 05 0110	110	450	48	166	15000
0700 05 0115	115	450	48	166	14830
0700 05 0120	120	490	54	178	18865

0750

Yıldız Çakma Anahtar (mm)
Slugging Ring Wrench (mm)

TS 3794• DIN 7444

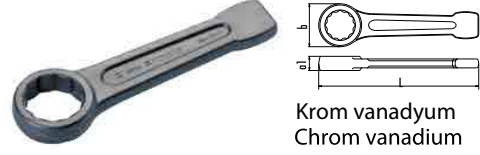

KOD CODE	mm	L mm	a1 mm	b mm	g
0750 05 0024	24	160	15	42	235
0750 05 0027	27	180	16	46	325
0750 05 0030	30	190	17	52	435
0750 05 0032	32	190	17	52	425
0750 05 0036	36	205	19	59	550
0750 05 0038	38	205	19	59	530
0750 05 0041	41	225	20	64	730
0750 05 0042	42	225	20	64	700
0750 05 0046	46	240	22	73	970
0750 05 0047	47	240	22	73	930
0750 05 0050	50	255	23	78	1160
0750 05 0055	55	272	25	88	1520
0750 05 0060	60	272	25	88	1460
0750 05 0065	65	300	28	100	2025
0750 05 0070	70	330	32	109	2890
0750 05 0075	75	330	32	109	2755
0750 05 0080	80	360	35	123	4000
0750 05 0085	85	360	35	123	3620
0750 05 0090	90	390	40	142	5465
0750 05 0095	95	390	40	142	5250
0750 05 0100	100	420	44	152	6755
0750 05 0105	105	420	44	152	6445
0750 05 0110	110	450	46	165	8500
0750 05 0115	115	450	46	165	8460
0750 05 0120	120	490	54	178	10000



1107

1/4" Altı Köşe Lokma Anahtar (mm)
Socket Wrench 6 Points (mm)



1/4"

Krom vanadyum, Krom kaplı , Polisajlı
Chrom vanadium, Chrom plated, Polished

KOD CODE	mm	Ø D1 mm	Ø D2 mm	L mm	L1 mm	g
1107 06 0004	4	6.8	11.8	24.5	4	10
1107 06 0045	4.5	7.4	11.8	24.5	5	10
1107 06 0005	5	8	11.8	24.5	6	10
1107 06 0055	5.5	8.7	11.8	24.5	6	10
1107 06 0006	6	9.2	11.8	24.5	7	10
1107 06 0007	7	10.3	11.8	24.5	7	10
1107 06 0008	8	11.4	11.8	24.5	8	10
1107 06 0009	9	12.9	12.2	24.5	8	15
1107 06 0010	10	14.3	13	24.5	9	20
1107 06 0011	11	15.8	14.2	24.5	9	20
1107 06 0012	12	16.8	15.5	24.5	9	25
1107 06 0013	13	17.8	16.5	24.5	9	30

1107

1/4" Altı Köşe Derin Lokma Anahtar (mm)
Deep Socket Wrench 6 Points (mm)



1/4"

Krom vanadyum, Krom kaplı , Polisajlı
Chrom vanadium, Chrom plated, Polished

KOD CODE	mm	Ø D1 mm	Ø D2 mm	L mm	L1 mm	g
1107 06 4004	4	6.8	11.8	50	6	10
1107 06 4005	5	8	11.8	50	7	20
1107 06 4055	5.5	8.7	11.8	50	9	20
1107 06 4006	6	9.2	11.8	50	9	25
1107 06 4007	7	10.3	11.8	50	15	25
1107 06 4008	8	11.8	11.8	50	15	25
1107 06 4009	9	13	13	50	15	30
1107 06 4010	10	14.5	14.5	50	15	40
1107 06 4011	11	15.8	15.8	50	21	45
1107 06 4012	12	16.8	16.8	50	21	50
1107 06 4013	13	17.8	17.8	50	21	55

1507

1/4" Cırcır Kolu
Ratchet Handle

TS ISO 3315 • DIN 3122

1/4"



KOD CODE	L mm	g
1507 06 0140	140	140

1507

1/4" Ara Kol
Extension Bar

TS ISO 1174 • DIN 3123

1/4"



KOD CODE	L mm	g
1507 06 0050	50	25
1507 06 0100	100	45

1507

1/4" Mafsallı
Universal Joint

TS ISO 1174 • DIN 3123

1/4"



KOD CODE	L mm	g
1507 06 0038	38	25

1110

3/8" Altı Köşe Lokma Anahtar (mm)
Socket Wrench 6 Points (mm)

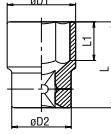

3/8"

Krom vanadyum, Krom kaplı , Polisajlı
Chrom vanadium, Chrom plated, Polished

KOD CODE	mm	Ø D1 mm	Ø D2 mm	L mm	L1 mm	g
1110 06 0006	6	9.8	17.8	27	9	25
1110 06 0007	7	10.8	17.8	27	9	25
1110 06 0008	8	12	17.8	27	9	25
1110 06 0009	9	13.2	17.8	27	9	25
1110 06 0010	10	14.5	17.8	27	9	25
1110 06 0011	11	15.8	17.8	27	9	30
1110 06 0012	12	16.8	17.8	27	9	30
1110 06 0013	13	17.8	16.8	27	9	30
1110 06 0014	14	19.6	17.5	29	11	35
1110 06 0015	15	20.8	18	29	11	45
1110 06 0016	16	21.8	19	29	11	45
1110 06 0017	17	23.4	20	29	11	55
1110 06 0018	18	24.7	21	29	13	60
1110 06 0019	19	25.8	22	29	13	65
1110 06 0021	21	27.8	24	32	13	80
1110 06 0022	22	29.7	26	32	15	85
1110 06 0023	23	29.7	26	32	15	90

1110

3/8" Buji Lokma Anahtar Lastikli
Spark Plug Socket with Rubber



3/8"

KOD CODE	mm	L mm	g
1110 06 9208	21	70	145



1510

3/8" Cırcır Kolu
Ratchet Handle

TS ISO 3315 • DIN 3122



3/8"

Krom vanadyum, Krom kaplı , Polisajlı
Chrom vanadium, Chrom plated, Polished

KOD CODE	L mm	g
1510 06 0200	200	295

1510

3/8" Ara Kol
Extension Bar

TS ISO 1174 • DIN 3123



3/8"

Krom vanadyum, Krom kaplı , Polisajlı
Chrom vanadium, Chrom plated, Polished

KOD CODE	L mm	g
1510 06 0075	75	75
1510 06 0150	150	145

1510

3/8" Mafsal
Universal Joint

TS ISO 1174 • DIN 3123



3/8"

Krom vanadyum, Krom kaplı , Polisajlı
Chrom vanadium, Chrom plated, Polished

KOD CODE	L mm	g
1510 06 0056	56.5	60

1510

3/8" T Kol
Sliding T - Handle

TS ISO 3315 • DIN 3122



3/8"

Krom vanadyum, Krom kaplı , Polisajlı
Chrom vanadium, Chrom plated, Polished

KOD CODE	L mm	g
1510 06 1200	200	180

1513

1/2" Lokma Adaptörü
Adapter

TS ISO 1174 • DIN 3123



1/2"

KOD CODE	inch	g
1513 06 0002	1/2"Fx3/8"M	55
1513 06 0003	1/2"Fx3/4"M	115

1513

1/2" Mafsal
Universal Joint

TS ISO 1174 • DIN 3123



1/2"

Krom vanadyum, Krom kaplı, Polisajlı
Chrom vanadium, Chrom plated, Polished

KOD CODE	L mm	g	TL/Ad.
1513 06 4070	70	140	5 43,97

1513

1/2" Cırcır Kolu (32 Diş)
Ratchet Handle

TS ISO 3315 • DIN 3122



1/2"

KOD CODE	L mm	g
1513 06 0032	250	580

1113

1/2" Altı Köşe Lokma Anahtar (mm)
Socket Wrench 6 Points (mm)

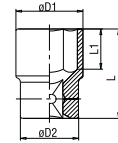

1/2"

Krom vanadyum, Krom kaplı
Chrom vanadium, Chrom plated,

1513

1/2" Cırcır Kolu (72 Diş)
Max Gear Raichet Handle

TS ISO 3315 • DIN 3122



1/2"

KOD CODE	L mm	g
1513 06 0072	250	460

1513

1/2" Ara Kol
Extension Bar

TS ISO 1174 • DIN 3123



1/2"

KOD CODE	L mm	g
1513 06 4075	75	140
1513 06 4125	125	215
1513 06 4250	250	420

KOD CODE	mm	ø D1 mm	ø D2 mm	L mm	L1 mm	g
1113 06 1008	8	13.2	21.8	38	7	55
1113 06 1009	9	14	21.8	38	7	55
1113 06 1010	10	15	23.3	38	8	55
1113 06 1011	11	16.4	23.3	38	8	60
1113 06 1012	12	17.8	23.3	38	9	60
1113 06 1013	13	19	23.3	38	10	65
1113 06 1014	14	20.4	23.3	38	11	65
1113 06 1015	15	21.6	23.3	38	11	65
1113 06 1016	16	22.9	24	38	11	70
1113 06 1017	17	24	22.5	38	12	70
1113 06 1018	18	25.2	23	38	13	75
1113 06 1019	19	26.8	23	38	13	75
1113 06 1020	20	28	23	38	13	80
1113 06 1021	21	29.2	23	38	13	85
1113 06 1022	22	30.2	24	40	15	95
1113 06 1023	23	31.4	25	40	15	100
1113 06 1024	24	32.6	26	42	17	115
1113 06 1025	25	34	27	42	17	125
1113 06 1026	26	35.3	28	42	17	135
1113 06 1027	27	36.6	28	42	19	140
1113 06 1028	28	37.8	30	42	20	160
1113 06 1029	29	39	30	44	21	170
1113 06 1030	30	40	29.5	44	21	180
1113 06 1032	32	42.5	30	44	23	190

4100

Kraft Seri Düz Uçlu Tornavida
Screwdriver, Kraft, Flat

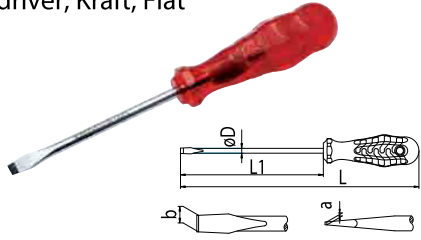

Krom vanadyum, Krom kaplı,
Ucu siyah oksit, Selüloz asetat saplı
Chrom vanadium, Chrom plated and black tips,
Cellulose acetate handle.

KOD CODE	ØDxL1 mm	⊖		L mm	g
		a mm	b mm		
4100 17 0340	3x40	0.5	3	110	20
4100 17 0380	3x80	0.5	3	155	35
4100 17 0480	4x80	0.8	4	165	50
4100 17 4100	4x100	0.8	4	185	50
4100 17 0580	5x80	1.0	5.5	175	70
4100 17 5100	5x100	1.0	5.5	195	75
4100 17 5125	5x125	1.0	5.5	220	80
4100 17 5150	5x150	1.0	5.5	245	80
4100 17 6100	6x100	1.2	6.5	195	85
4100 17 6125	6x125	1.2	6.5	220	90
4100 17 6150	6x150	1.2	6.5	245	95
4100 17 6175	6x175	1.2	6.5	270	100
4100 17 7125	7x125	1.2	8	230	120
4100 17 7150	7x150	1.2	8	255	130
4100 17 7175	7x175	1.2	8	280	135
4100 17 8150	8x150	1.6	10	255	145
4100 17 8175	8x175	1.6	10	280	150
4100 17 8200	8x200	1.6	10	305	160
4100 17 9200	9x200	2.0	12	305	190
4100 17 1125	11x250	2.5	14	365	305

4100

Kraft Seri Düz Uçlu Tornavida Seti (8 Parça)
Screwdriver, Flat, Kraft Set (8 Pcs)



KOD CODE	İÇERİK CONTENTS	g
4100 00 8108	3x80 - 4x80 - 4x100 5x100 - 5x125 - 6x100 6x125 - 6x150 ⊖ Düz uçlu/Flat	550

4100

Kraft Seri Süngüsü Uzun Düz Uçlu Tornavida
Screwdriver, Kraft, Flat, Long

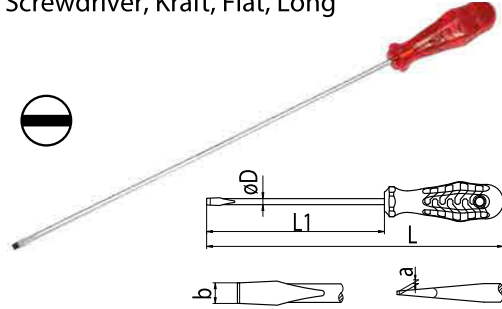

Krom vanadyum, Krom kaplı,
Ucu siyah oksit, Selüloz asetat saplı
Chrom vanadium, Chrom plated and black tips,
Cellulose acetate handle.

KOD CODE	L mm	g
1513 06 4075	75	140
1513 06 4125	125	215
1513 06 4250	250	420

4100

Kraft Seri Tornavida Seti (7 parça)
Screwdriver, Kraft Set (7 Pcs)



KOD CODE	İÇERİK CONTENTS	g
4100 00 8107	3x80 - 4x80 - 4x100 ⊖ 5x125 - 6x150 Düz uçlu/Flat ⊕ 4.5x80 - 6x100 Yıldız uçlu/Phillips	445

4120

Kraft Seri Yıldız Uçlu Tornavida
Screwdriver, Kraft, Phillips TS 59 - DIN ISO 8764

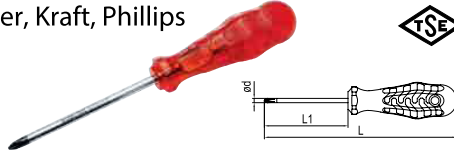

Krom vanadyum, Krom kaplı,
Ucu siyah oksit, Selüloz asetat saplı
Chrom vanadium, Chrom plated and black tips,
Cellulose acetate handle.

KOD CODE	ødxL1 mm	+	L mm	g
4120 18 0360	3x60	Ph0	135	30
4120 18 4580	4.5x80	Ph1	165	55
4120 18 5100	4.5x100	Ph1	185	55
4120 18 5150	4.5x150	Ph1	235	60
4120 18 6100	6x100	Ph2	195	85
4120 18 6150	6x150	Ph2	245	95
4120 18 6200	6x200	Ph2	295	105
4120 18 8150	8x150	Ph3	255	150
4120 18 1200	10x200	Ph4	315	240

4120

Kraft Seri Süngüsü Uzun Yıldız Uçlu Tornavida
Screwdriver, Kraft, Phillips, Long

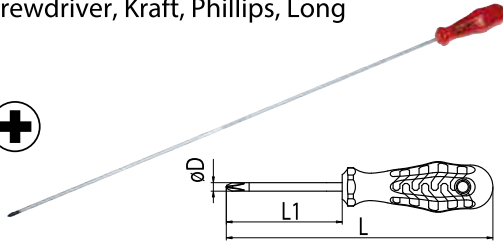

Krom vanadyum, Krom kaplı,
Ucu siyah oksit, Selüloz asetat saplı
Chrom vanadium, Chrom plated and black tips,
Cellulose acetate handle.

KOD CODE	øDxL1 mm	+	L mm	g
4120 18 5300	4.5x300	Ph1	385	80
4120 18 6300	6x300	Ph2	395	125



4120

Kraft Seri Yıldız Uçlu Tornavida Seti (6 parça)
Screwdriver, Kraft, Phillips, Set (6 Pcs)



KOD CODE	İÇERİK CONTENTS	g
4120 00 8106	3x60 - 4.5x80 4.5x100 - 4.5x150 6x100 - 6x150 Yıldız uçlu/Phillips	380

4110

Kraft Seri Düz Uçlu Topaç Tornavida
Screwdriver, Kraft, Stubby, Flat

TS 59 - DIN 5264 - DIN 5265

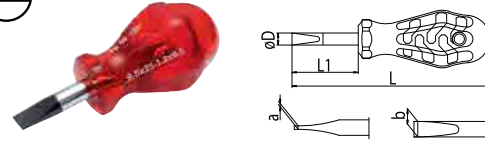

KOD CODE	øDxL1 mm	-		L mm	g
		a mm	b mm		
4110 17 5525	5.5x25	1	5.5	70	30
4110 17 5540	5.5x40	1	5.5	105	45
4110 17 6525	6.5x25	1.2	6.5	70	35
4110 17 6540	6.5x40	1.2	6.5	105	50

4130

Kraft Seri Yıldız Uçlu Topaç Tornavida
Screwdriver, Kraft, Stubby, Phillips

TS 59 - DIN ISO 8764

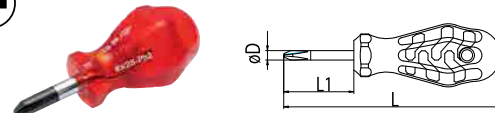

KOD CODE	øDxL1 mm	+	L mm	g
4130 18 4525	4.5x25	Ph1	70	30
4130 18 4540	4.5x40	Ph1	105	40
4130 18 0625	6x25	Ph2	70	30
4130 18 0640	6x40	Ph2	105	50

4770

Lokma Uçlu Tornavida Seti (8 Parça, mm)
Nut Spinner Set (8 Pcs, mm)



KOD CODE	İÇERİK CONTENTS	g
4770 00 8108	6 - 7 - 8 - 9 - 10 11 - 12 - 13	2145

4770

Lokma Uçlu Tornavida (mm) TS 3793 • DIN 3125
Nut Spinner (mm)

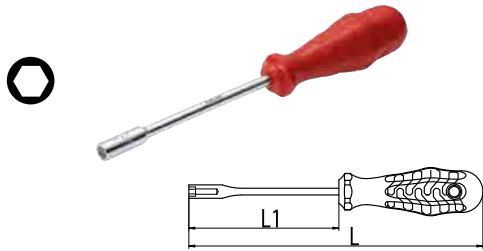

Krom vanadyum, Krom kaplı, PP Saplı
Chrom vanadium, Chrom plated, PP insulated

KOD CODE	mm	L mm	L1 mm	g
4770 19 0040	4	220	125	80
4770 19 0050	5	220	125	80
4770 19 0055	5.5	220	125	80
4770 19 0060	6	220	125	80
4770 19 0070	7	230	125	100
4770 19 0080	8	230	125	110
4770 19 0090	9	230	125	115
4770 19 0100	10	230	125	115
4770 19 0110	11	230	125	130
4770 19 0120	12	230	125	135
4770 19 0130	13	230	125	140
4770 19 0140	14	230	125	140

4790

Üniversal Bits Adaptörü (Manyetik)
Screwdriver Universal Bit Holder
(Magnetic)

TS 8748 • DIN 3126 • DIN 7427



KOD CODE	mm	mm	L mm	g
4790 26 6360	6.3	6.3	60	25

4775

Torx® Uçlu Tornavida
Torx® Driver

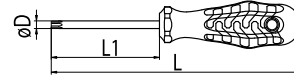

KOD CODE	ØDxL1 mm	Star	L mm	g
4775 18 0010	4x80	T10	165	35
4775 18 0015	4x80	T15	165	35
4775 18 0020	4x100	T20	185	40
4775 18 0025	4.5x100	T25	185	40
4775 18 0027	5x125	T27	220	60
4775 18 0030	6x125	T30	220	70
4775 18 0040	7x125	T40	230	100
4775 18 0045	8x125	T45	230	120

4776

Delikli Torx® Uçlu Tornavida
Torx® Screwdriver / tamper Resistance

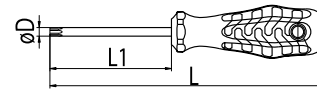

KOD CODE	ØDxL1 mm	Star	L mm	g
4776 18 0009	4x60	TR9	145	35
4776 18 0010	4x80	TR10	165	35
4776 18 0015	4x80	TR15	165	40
4776 18 0020	4x100	TR20	185	40
4776 18 0025	4.5x100	TR25	185	45
4776 18 0027	5x125	TR27	220	60
4776 18 0030	6x125	TR30	220	70
4776 18 0040	7x125	TR40	230	100

4900

Allen Anahtar Altı Köşe (mm)
Hex Key Wrench (mm)

TS ISO 2936

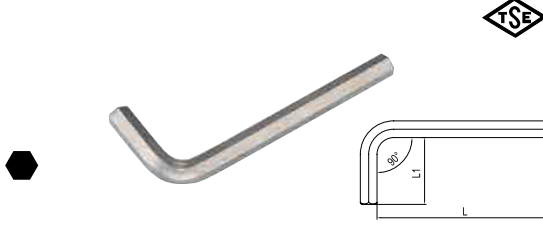

Krom vanadyum, Nikel kaplı
Chrom vanadium, Nickel Plated

KOD CODE	mm	L mm	L1 mm	g
4900 22 0015	1.5	45	14	1.5
4900 22 0020	2	50	16	2
4900 22 0025	2.5	56	18	4
4900 22 0030	3	63	20	6
4900 22 0035	3.5	66	22	8
4900 22 0040	4	70	25	10
4900 22 0050	5	80	28	20
4900 22 0060	6	90	32	30
4900 22 0070	7	95	34	40
4900 22 0080	8	100	36	55
4900 22 0090	9	105	38	75
4900 22 0100	10	112	40	100
4900 22 0120	12	125	45	160
4900 22 0140	14	140	56	250
4900 22 0160	16	152	60	375
4900 22 0170	17	160	63	425
4900 22 0190	19	180	70	610
4900 22 0220	22	200	80	940
4900 22 0240	24	224	90	1250

4903

Allen Anahtar Altı Köşe Uzun Boy (mm) TS ISO 2936
Hex Key Wrench Long Pattern (mm)



Krom vanadyum, Nikel kaplı
Chrom vanadium, Nickel Plated

KOD CODE	mm	L mm	L1 mm	g
4903 22 0020	2	100	16	3
4903 22 0025	2.5	112	18	5
4903 22 0030	3	126	20	10
4903 22 0035	3.5	136.5	22	15
4903 22 0040	4	140	25	20
4903 22 0050	5	160	28	30
4903 22 0060	6	180	32	50
4903 22 0070	7	190	34	80
4903 22 0080	8	200	36	100
4903 22 0090	9	210	38	145
4903 22 0100	10	224	40	180
4903 22 0120	12	250	45	285
4903 22 0140	14	280	56	460
4903 22 0160	16	300	60	625
4903 22 0170	17	320	63	750
4903 22 0190	19	360	70	1100

4900

Allen Anahtar Takım Altı Köşe (mm)
Hex Key Wrench Set (mm)



KOD CODE	İÇERİK CONTENTS	g
4900 00 3110	2 - 2.5 - 3 - 4 - 5 - 6 7 - 8 - 9 - 10	400
4900 00 3112	2 - 2.5 - 3 - 3.5 - 4 - 5 6 - 7 - 8 - 9 - 10 - 12	565

4903

Allen Anahtar Takım Altı Köşe Uzun Boy (mm)
Hex Key Wrench Set Long Pattern (mm)



KOD CODE	İÇERİK CONTENTS	g
4903 00 3110	2 - 2.5 - 3 - 4 - 5 - 6 7 - 8 - 9 - 10	660
4903 00 3112	2 - 2.5 - 3 - 3.5 - 4 - 5 6 - 7 - 8 - 9 - 10 - 12	940



4905

Yuvarlak Başlı Allen Anahtar (mm)
Hex Key Wrench Ballpoint (mm)



Krom vanadyum, Siyah oksit kaplı
Chrom vanadium, Black finish

KOD CODE	mm	L mm	L1 mm	g
4905 22 0020	2	50	16	3
4905 22 0025	2.5	56	18	4
4905 22 0030	3	63	20	5
4905 22 0040	4	70	25	10
4905 22 0050	5	80	28	20
4905 22 0060	6	90	32	30
4905 22 0080	8	100	36	55
4905 22 0100	10	112	40	100

4906

Yuvarlak Başlı Allen Anahtar Uzun Boy (mm)
Hex Key Wrench Ballpoint Long Pattern (mm)

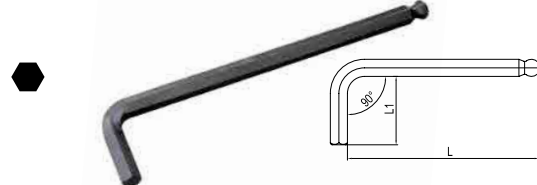

Krom vanadyum, Siyah oksit kaplı
Chrom vanadium, Black finish

KOD CODE	mm	L mm	L1 mm	g
4906 22 0015	1.5	79	12	1.5
4906 22 0020	2	84	16	3
4906 22 0025	2.5	89	16	5
4906 22 0030	3	99	18	7
4906 22 0040	4	109	23	13
4906 22 0050	5	125	26	25
4906 22 0060	6	150	28	42
4906 22 0080	8	167	33	85
4906 22 0100	10	190	37	150

4905

Yuvarlak Başlı Allen Anahtar Takımı (8 Parça, mm)
Hex Key Wrench Ballpoint Set (8 Pcs, mm)



KOD CODE	İÇERİK CONTENTS	g
4905 00 7108	2 - 2.5 - 3 - 4 5 - 6 - 8 - 10	275

4906

Yuvarlak Başlı Allen Anahtar Takım Altı Köşe Uzun Boy (mm)
Hex Key Wrench Ballpoint Long Pattern Set (mm)



KOD CODE	İÇERİK CONTENTS	g
4906 00 3109	1.5 - 2 - 2.5 - 3 - 4 - 5 - 6 8 - 10	355



4920

T Tipi Allen Anahtar (mm)
Hex Key Wrench T - Handle (mm)

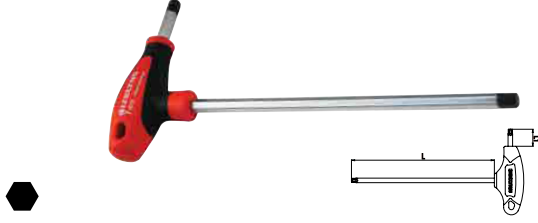

Krom vanadyum, Krom kaplı, PP saplı
Chrom vanadium, Chrom plated, PP handle

KOD CODE	mm	L mm	L1 mm	g
4920 22 0025	2.5	110	14	20
4920 22 0030	3	125	17	23
4920 22 0040	4	140	20	45
4920 22 0050	5	155	23	58
4920 22 0060	6	170	26	100
4920 22 0070	7	185	30	125
4920 22 0080	8	200	34	150
4920 22 0100	10	220	40	240

4921

Yuvarlak Başlı T Tipi Allen Anahtar (mm)
Hex Key Wrench T - Handle Ballpoint (mm)



Krom vanadyum, Krom kaplı, PP saplı
Chrom vanadium, Chrom plated, PP handle

KOD CODE	mm	L mm	L1 mm	g
4921 22 0025	2.5	110	14	20
4921 22 0030	3	125	17	23
4921 22 0040	4	140	20	45
4921 22 0050	5	155	23	58
4921 22 0060	6	170	26	100
4921 22 0070	7	185	30	125
4921 22 0080	8	200	34	150
4921 22 0100	10	220	40	235

4920

T Tipi Allen Anahtar Takımı (8 Parça, mm)
Hex Key Wrench T - Handle Set (8 Pcs, mm)



KOD CODE	İÇERİK CONTENTS	g
4920 00 8108	2.5 - 3 - 4 - 5 6 - 7 - 8 - 10	760

4921

Yuvarlak Başlı T Tipi Allen Anahtar Takımı (8 Parça, mm)
Hex Key Wrench T - Handle Ballpoint Set (8 Pcs, mm)



KOD CODE	İÇERİK CONTENTS	g
4921 00 8108	2.5 - 3 - 4 5 - 6 - 7 - 8 - 10	755

3020

Kombine Pense Opak
Combination Pliers

TS 60 • TS 11068 • DIN ISO 5744
DIN ISO 5746



KOD CODE	L mm	L inch	MODEL	g
3020 12 2160	160	6 1/4"	OPAK	205
3020 12 2180	180	7 1/8"	OPAK	275
3020 12 2200	200	8"	OPAK	315

2400

Universal Fort Pense
Waterpump Pliers Standard

TS 60 • DIN ISO 89

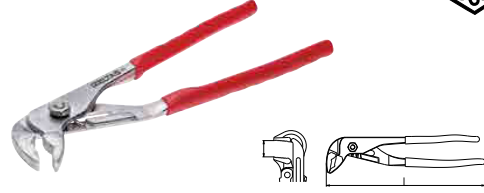

Krom vanadyum, Krom kaplı, PVC izoleli
Chrom vanadium, Chrom plated, PVC insulated

KOD CODE	L mm	L inch	mm	g
2400 11 0160	160	6 1/4"	30	125
2400 11 0240	240	9 1/2"	35	355
2400 11 0315	315	12 1/2"	40	530

3220

Uzun Kargaburun Düz Uçlu Opak
Long Nose Pliers (Flat)

TS 60 • TS 11067



KOD CODE	L mm	L inch	MODEL	g
3220 13 2140	140	5 1/2"	OPAK	110
3220 13 2160	160	6 1/4"	OPAK	135
3220 13 2180	180	7 1/8"	OPAK	170
3220 13 2200	200	8"	OPAK	205

2505

Standart Ayarlı Pense
Standard Grip

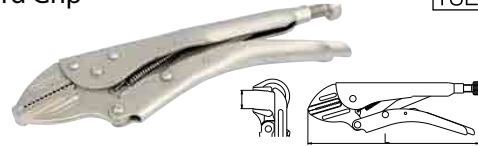

Çeneler krom vanadyum çeliğinden dövülmüştür,
Nikel kaplama
Kullanım sahası: Düz malzemeler
Jaws, Chrom vanadium forged, Nickel plated
Applicatation field : Flat materials

KOD CODE	L mm	L inch	mm	g
2505 11 0250	250	10"	30	535

3700

Yan Keski Opak
Side Cutting Pliers

TS 60 • DIN ISO 5749



KOD CODE	L mm	L inch	MODEL	g
3700 16 2140	140	5 1/2"	OPAK	165
3700 16 2160	160	6 1/4"	OPAK	230
3700 16 2180	180	7 1/8"	OPAK	230

6801

Kuyumcu Makası (Eğri)
Jeweller's Snips (Curved)



KOD CODE	L mm	L inch	g
6801 27 0180	180	7 1/8"	140

3301

Dış Segman Pense (Yaylı Düz)
Circlip Pliers, External (Flat)

TS 60 • DIN 5254



KOD CODE	L mm	ÖLÇÜ SIZE	ÖLÇÜ SIZE	ÖLÇÜ SIZE
3301 12 0140	140	10 - 25	90	
3301 12 0180	180	19 - 60	195	
3301 12 0225	225	40 - 100	235	
3301 12 0295	295	85 - 165	445	

3321

İç Segman Pensi (Yaysız Düz)
Circlip Pliers Internal (Flat)

TS 60 • DIN 525



KOD CODE	L mm	ÖLÇÜ SIZE	ÖLÇÜ SIZE	ÖLÇÜ SIZE
3321 12 0140	140	8 - 25	100	
3321 12 0180	180	19 - 60	185	
3321 12 0225	225	40 - 100	250	
3321 12 0310	310	85 - 165	445	

3311

Dış Segman Pense (Yaylı Eğri)
Circlip Pliers, External (Bent)

TS 60 • DIN 525



KOD CODE	L mm	ÖLÇÜ SIZE	ÖLÇÜ SIZE	ÖLÇÜ SIZE
3311 12 0125	125	10 - 25	105	
3311 12 0170	170	19 - 60	190	
3311 12 0210	210	40 - 100	250	
3311 12 0275	275	85 - 165	445	

3331

İç Segman Pensi (Yaysız Eğri)
Circlip Pliers Internal (Bent)

TS 60 • DIN 5256



KOD CODE	L mm	ÖLÇÜ SIZE	ÖLÇÜ SIZE	ÖLÇÜ SIZE
3331 12 0130	130	8 - 25	105	
3331 12 0170	170	19 - 60	185	
3331 12 0210	210	40 - 100	250	
3331 12 0290	290	85 - 165	440	

2100

Stilson Boru Anahtarı
Pipe Wrench, Stilson



TS 3796

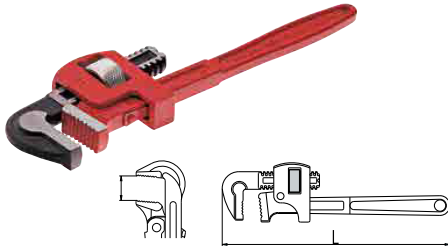

KOD CODE	L mm	L inch	ÖLÇÜ SIZE	ÖLÇÜ SIZE	ÖLÇÜ SIZE
2100 10 0008	200	8"	27	3/4"	280
2100 10 0010	250	10"	34	1"	550
2100 10 0012	300	12"	42	1 1/4"	725
2100 10 0014	350	14"	50	1 1/2"	1030
2100 10 0018	450	18"	60	2"	1775
2100 10 0024	600	24"	76	2 1/2"	2775
2100 10 0036	900	36"	100	3 1/2"	6000

2201

Maşalı Boru Anahtarı (85°)
Pipe Wrench (85°)

DIN 5234

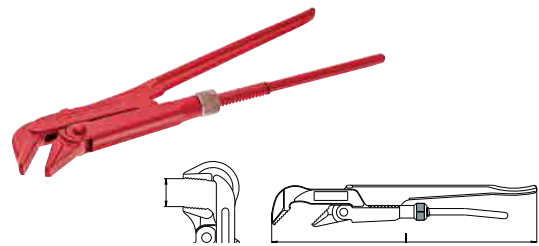

KOD CODE	L mm	ÖLÇÜ SIZE	ÖLÇÜ SIZE	ÖLÇÜ SIZE
2201 10 0010	325	40	1"	870
2201 10 0015	430	60	1 1/2"	1585
2201 10 0020	585	70	2"	2700
2201 10 0030	690	100	3"	4270
2201 10 0040	760	130	4"	5800

6210

Kaportacı Makası (Sağ)
Punch Snip (Right)

DIN 6438

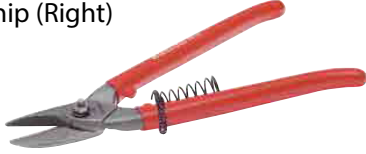

KOD CODE	L mm	L inch	g
6210 27 0250	250	10"	555
6210 27 0275	275	11"	600
6210 27 0300	300	12"	640

6211

Kaportacı Makası (Sol)
Punch Snip (Left)

DIN 6438



KOD CODE	L mm	L inch	g
6211 27 0250	250	10"	535
6211 27 0275	275	11"	605
6211 27 0300	300	12"	665

6821

Tenekeci Makası (Yaylı)
Tinman's Snip (With Spring)



KOD CODE	L mm	L inch	g
6821 27 0250	250	10"	575
6821 27 0300	300	12"	895

6350

Levye Oluklu
Tyre Lever, Straight



KOD CODE	L mm	L inch	g
6350 26 0300	300	12"	265
6350 26 0400	400	16"	440
6350 26 0500	500	20"	675
6350 26 0600	600	24"	900

5850

Plastik Çekiç
Plastic Hammer

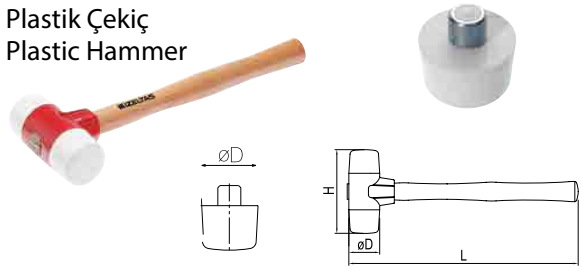

KOD CODE	L mm	ØD mm	H mm	g
5850 25 0030	300	30	100	345
5850 25 0040	320	40	110	645
5850 25 0050	350	50	120	1015

5800

Tesviyeci Çekiç
Machinist's Hammer

TS 5 - DIN 1041

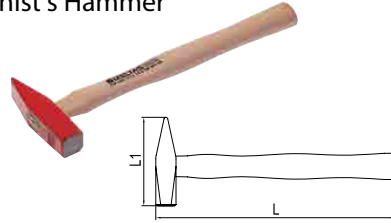

KOD CODE	L mm	L1 mm	g	g
5800 25 0100	260	82	100	160
5800 25 0200	280	95	200	260
5800 25 0300	300	105	300	395
5800 25 0500	320	118	500	600
5800 25 1000	360	135	1000	1095
5800 25 1500	380	145	1500	1630
5800 25 2000	400	155	2000	2100

6225

Madeni Yağdanlık (Flexible Uçlu)
Oiler With Flexible Spout



KOD CODE	ÖLÇÜ SIZE cc	g
6225 26 0200	200	170
6225 26 0300	300	200
6225 26 0500	500	225

1107

1/4" Karbüratör Lokma Takımı
(18 parça, mm)
Socket Wrench Set
(18 pcs, mm)



1/4"

KOD CODE	LOKMALAR Sockets	AVADANLIKLAR Accessories	g
1107 00 6018	4 - 5 - 6 7 - 8 - 9 - 10 11 - 12 - 13 Altı Köşe Six Points 8 - 10 Sekiz Köşe Eight Points	1/4" Cırcır kolu Ratchet Handle	960
		1/4" Mafsal Universal Joint	
		1/4" T Kol Sliding T Handle	
		1/4" Ara Kol Extension Bar 50 mm	
		1/4" Ara Kol Extension Bar 100 mm	
		1/4" Mafsalı Kol Flexible Handle	

1113

1/2" Altı Köşe Lokma Anahtar Takımı (24 Parça, mm)
Socket Wrench Set 1/2" 6 Points (24 pcs, mm)



1/2"

KOD CODE	LOKMALAR Sockets	AVADANLIKLAR Accessories	g
1113 00 2024	10 - 11 - 12 13 - 14 - 15 16 - 17 - 18 19 - 21 - 22 23 - 24 - 26 27 - 28 - 30 32	1/2" Cırcır Kolu Ratchet Handle	3650
		1/2" Mafsal Universal Joint	
		1/2" T Kol Sliding T Handle	
		1/2" Ara Kol Extension Bar 125 mm	
		1/2" Ara Kol Extension Bar 250 mm	

1110

3/8" Altı Köşe Lokma Takımı (20 parça, mm)
6 Points Socket Wrench Set (20 Pcs, mm)



3/8"

KOD CODE	LOKMALAR Sockets	AVADANLIKLAR Accessories	g
1110 00 6020	6 - 7 - 8 - 9 - 10 11 - 12 - 13 - 14 17 - 19 - 21 22 Altı Köşe Six Points 20.8 Buji Lokma Lastikli Altı Köşe Rubber Six Points	3/8" Cırcır Kolu Ratchet Handle	2500
		3/8" Mafsal Universal Joint	
		3/8" T Kol Sliding T Handle	
		3/8" Ara Kol Extension Bar 75 mm	
		3/8" Ara Kol Extension Bar 150 mm	
		3/8" Mafsalı Kol Flexible Handle	

GWS 7-115
Avuç Taşlama



Giriş gücü
720 W
Boştaki devir sayısı
2.800 – 11.000 dev/dak
Disk çapı
115 mm

GWS 9-115
Avuç Taşlama



Giriş gücü
900 W
Boştaki devir sayısı
11.500 dev/dak
Disk çapı
115 mm

GWS 22-180
Taşlama



Giriş gücü
2.200 W
Boştaki devir sayısı
8.500 dev/dak
Disk çapı
180 mm

GWS 24-230 H
Taşlama



Giriş gücü
2.400 W
Boştaki devir sayısı
6.500 dev/dak
Disk çapı
230 mm

GGs 28 LCE
Delik Taşlama



Aksesuarlar



Giriş gücü
650 W
Boştaki devir sayısı
10.000 – 28.000 dev/dak
Uç girişi
8 mm'ye kadar penset

DREMEL 3000 1/25
Spiral Taşlama



Giriş gücü
130 W
Boştaki devir sayısı
33.000 dev/dak
Uç girişi
3 mm'ye kadar pens

GBM 13-2RE
Darbeli Matkap



Giriş gücü
550 W
Ahşapta delme çapı
32 / 20 mm
Çelikte delme çapı
13 / 8 mm

GBM 10 RE
Matkap



Giriş gücü : 600 W
Ahşapta delme çapı : 25 mm
Çelikte delme çapı : 10 mm



**Üniversal
Tulumba Pres**

- Konfeksiyon
- Sanayiinde ve kasül
- Düğmeye kumaş kaplar
- Rivet ve kuş gözü çit çit



**Manuel Darbeli Pres
4122**

Darbe Gücü:
max.1300 kg \ cm²
Parça Yüksekliği
320 mm
Tablo Genişliği
70 x 30 mm

- Konfeksiyon
- Sanayiinde ve kasül
- Düğmeye kumaş kaplar
- Rivet ve kuş gözü çit çit



**Elektrikli
Darbe Presi
4388**

Darbe Gücü
2.500 kg. / cm²
(Dijital ayarlanabilir)
Pens Deliği
Ø 9 mm.
Kapasite
Dakikada 25 vuruş

- Konfeksiyon sanayiinde de kot çakmada
- Ayakkabı ve terlik sanayiinde de kanca ve kuş gözü çakmada



**Pnömatik Darbeli
Markalama Presi
4241**

Darbe Gücü
1.300 kg / cm²
(Yay değiştirilerek ayarlanabilir.)
Parça Yüksekliği
320 mm
Tablo Genişliği
160 x 160

- Konfeksiyon sanayiinde kot düğme, rivet, çit çit çakmada
- Ayakkabı ve terlik sanayiinde kanca ve kuş gözü çakmada
- Elektrik, elektronik sanayiinde kullanılır.
- Kozmetik sanayiinde kullanılır.
- Otomotiv sanayiinde kullanılır.



**Hassas Masa
Matkabı
4156**

Mandren Devri
Max. 2810 dev. / dak.
Delme Gücü
Max. 6.5 mm.

- Zamak, toka, çanta aksesuarlarını sıvamada
- Elektrik ve elektronik montaj sanayisine
- Kuyumculuk sektöründe



**Hassas Masa
Matkabı
4152**

Motor Gücü: 200 W
Mandren Devri :
max. 25.000 dev / dak.
Delme Gücü:
max. 5 mm
Tablo Genişliği
160 x 160 mm.

- Emprimecilerde, hassas delik delmede
- Kuyumcu sektöründe verimliliği sağlar.
- Toka, çanta, zamak perçinlerini sıvamada
- Elektrik elektronik sanayiinde.

M-13

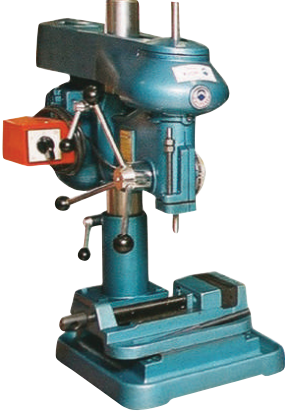

Tek Devir Matkap Tezgahı

Motor Gücü	0,55 Kw 1400 D / dk
Matkap Devri	450 - 4500 Devir Arası 5 Kademe
Delme Kapasitesi	13 mm
Delme Derinlik Mesafesi	90 mm
Mors Mili Koniği	B 16
Tabla ile Mandren Arasındaki	350 mm
Max. Yükseklik Mesafesi	170 mm
Sütun Mili ile Mandren Ucu Mesafesi	245 x 300
Tabla Kullanım Alanı	T-Papuç M10 x 12

DK-13

Tek Devir Klavuz Çeken Matkap Tezgahı



Motor Gücü	0,55 Kw 900 D / dk
Matkap Devri	280 - 2880 Devir Arası 5 Kademe
Delme Kapasitesi	16 mm
Diş Çekme Kapasitesi	M 12
Delme Derinlik Mesafesi	90 mm
Tabla ile Mandren Arasındaki	350 mm
Max. Yükseklik Mesafesi	170 mm
Sütun Mili ile Mandren Ucu Mesafesi	245 x 300
Tabla Kullanım Alanı	T-Papuç M10 x 12

Motor Gücü	0,55 Kw 1400 D / dk
Matkap Devri	450 - 4500 Devir Arası 5 Kademe
Delme Kapasitesi	13 mm
Diş Çekme Kapasitesi	M 10
Delme Derinlik Mesafesi	90 mm
Tabla ile Mandren Arasındaki	350 mm
Max. Yükseklik Mesafesi	170 mm
Sütun Mili ile Mandren Ucu Mesafesi	245 x 300
Tabla Kullanım Alanı	T-Papuç M10 x 12

2DK-13



Çift Devir Klavuz Çeken Matkap Tezgahı

Motor Gücü	0,35 Kw 0,55 Kw 700 / 1400 D / dk
Matkap Devri	200 - 4500 Devir Arası 10 Kademe
Delme Kapasitesi	13 mm - 16 mm
Diş Çekme Kapasitesi	M 12
Delme Derinlik Mesafesi	90 mm
Mors Mili Koniği	B 16
Tabla ile Mandren Arasındaki	350 mm
Max. Yükseklik Mesafesi	170 mm
Sütun Mili ile Mandren Ucu Mesafesi	245 x 300
Tabla Kullanım Alanı	T-Papuç M10 x 12

2755 CNC Sehpası

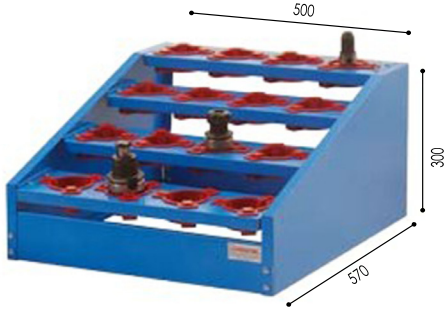

2750 CNC Sehpalı 4 Çekmeceli Takım Dolabı



2700 CNC Sehpalı 5 Çekmeceli Takım Dolabı



2600 CNC Sehpalı ve Üzeri Rafılı Takım Arabası



2650 5 Çekmeceli Takım Dolabı (1 CNC Çekmeceli)

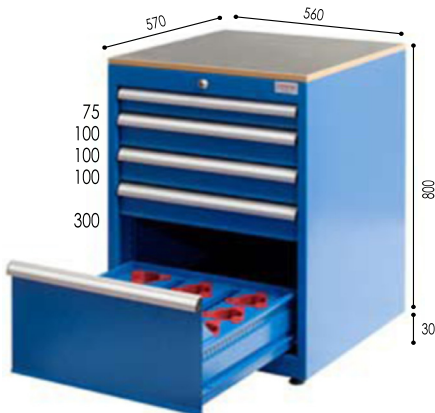

2740 4 Çekmeceli Takım Arabası (1 CNC Çekmeceli)



2300 CNC Arabası



2150 5 CNC Rafı Malzeme Dolabı



6051 Soyunma Dolabı



6052 Soyunma Dolabı



6053 Soyunma Dolabı



4086 Çift Yönlü Avadanlık Arabası



4089 Çift Yönlü Avadanlık Arabası

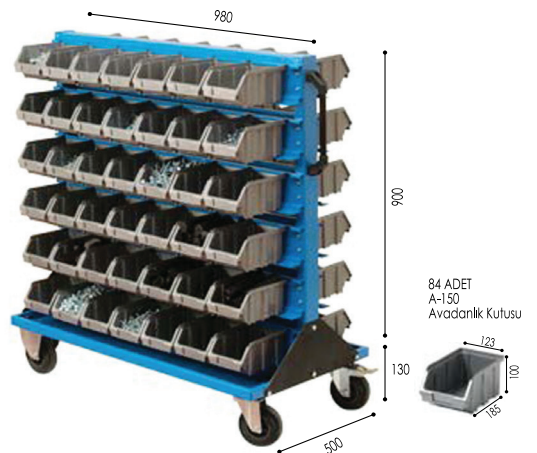

20949 10 Rafı Avadanlık Standı



MT401-180 180 Kutulu Dönerli Stand

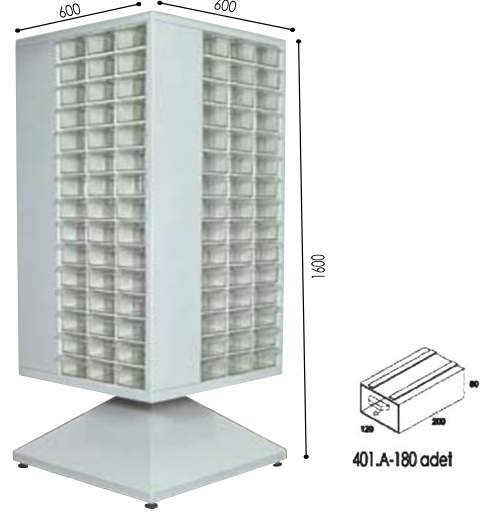

3750 Askı Panolu Çekmeceli Çalışma Masası



ÇKTS 401 154 Çekmeceli Stand

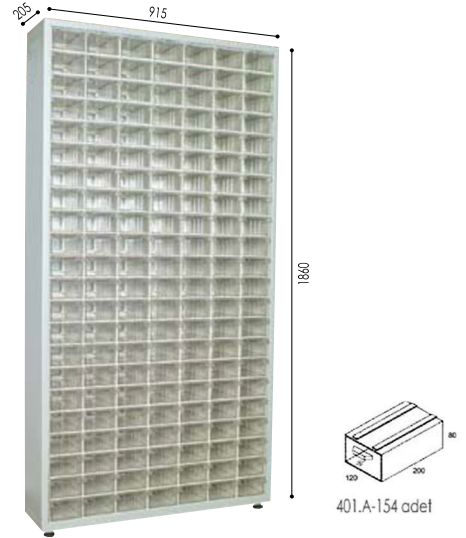

3705 İki Çekmeceli Panosuz Çalışma Masası

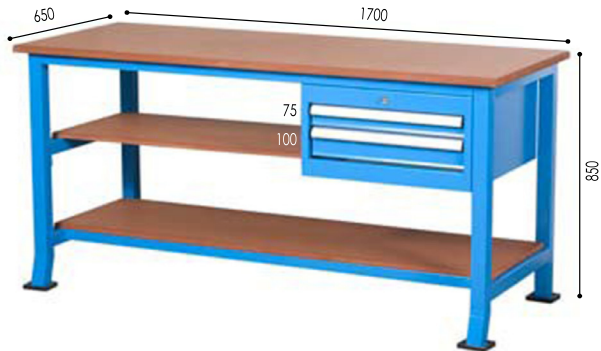

8075 5 Çekmeceli Takım Arabası



8072 2 Çekmeceli Raflı Takım Arabası



8074 4 Çekmeceli Takım Arabası



8027 5 Çekmeceli Panolu Çalışma Arabası



8040 3 Rafli Taşıma Sehpası



8026 2 Rafli Çalışma Arabası



8045 1 Çekmeceli 3 Rafli Taşıma Sehpası





102

Ebat / Size	En / W	Boy / L	Yük / H
Dış / Ext	85	120	40 mm
İç / Int	75	115	35 mm



102-D

Ebat / Size	En / W	Boy / L	Yük / H
Dış / Ext	85	120	80 mm
İç / Int	75	115	35 mm



202

Ebat / Size	En / W	Boy / L	Yük / H
Dış / Ext	100	140	52 mm
İç / Int	89	130	44 mm



322

Ebat / Size	En / W	Boy / L	Yük / H
Dış / Ext	96	140	125 mm
İç / Int	89	130	58 mm



132

Ebat / Size	En / W	Boy / L	Yük / H
Dış / Ext	83	134	103 mm
İç / Int	74	128	45 mm



133

Ebat / Size	En / W	Boy / L	Yük / H
Dış / Ext	83	134	103 mm
İç / Int	74	128	30 mm



136

Ebat / Size	En / W	Boy / L	Yük / H
Dış / Ext	83	134	103 mm
İç / Int	32	128	29 mm



132, 133 ve 136 birbirine monte edilebilir

132, 133 and 136 combinations can be created



141

Ebat / Size	En / W	Boy / L	Yük / H
Dış / Ext	103	134	83 mm
İç / Int	92	127	75 mm



142

Ebat / Size	En / W	Boy / L	Yük / H
Dış / Ext	103	134	83 mm
İç / Int	92	127	35 mm



144

Ebat / Size	En / W	Boy / L	Yük / H
Dış / Ext	103	134	83 mm
İç / Int	42	127	35 mm



141, 142 ve 144 birbirine monte edilebilir

141, 142 and 144 combinations can be created



302

Ebat / Size	En / W	Boy / L	Yük / H
Dış / Ext	106	122	62 mm
İç / Int	102	118	59 mm



301

Ebat / Size	En / W	Boy / L	Yük / H
Dış / Ext	106	122	62 mm
İç / Int	102	118	25 mm



305

Ebat / Size	En / W	Boy / L	Yük / H
Dış / Ext	106	122	62 mm
İç / Int	42	118	24 mm



301, 302 ve 305 birbirine monte edilebilir

301, 302 and 305 combinations can be created



351				
Ebat / Size	En / W	Boy / L	Yük / H	
Dış / Ext	110	170	65 mm	
İç / Int	96	160	55 mm	



321				
Ebat / Size	En / W	Boy / L	Yük / H	
Dış / Ext	125	140	96 mm	
İç / Int	114	130	84 mm	



325				
Ebat / Size	En / W	Boy / L	Yük / H	
Dış / Ext	125	140	96 mm	
İç / Int	56	130	42 mm	



321 ve 325 birbirine monte edilebilir
321 and 325 combinations can be created



390				
Ebat / Size	En / W	Boy / L	Yük / H	
Dış / Ext	132	205	63 mm	
İç / Int	120	197	52 mm	



410				
Ebat / Size	En / W	Boy / L	Yük / H	
Dış / Ext	132	205	83 mm	
İç / Int	120	197	75 mm	



420				
Ebat / Size	En / W	Boy / L	Yük / H	
Dış / Ext	132	205	132 mm	
İç / Int	120	197	124 mm	



390, 410 ve 420 birbirine monte edilebilir
390, 410 and 420 combinations can be created



401-A				
Ebat / Size	En / W	Boy / L	Yük / H	
Dış / Ext	120	200	80 mm	
İç / Int	110	197	70 mm	



500-A				
Ebat / Size	En / W	Boy / L	Yük / H	
Dış / Ext	132	230	98 mm	
İç / Int	125	221	85 mm	



451				
Ebat / Size	En / W	Boy / L	Yük / H	
Dış / Ext	173	230	110 mm	
İç / Int	162	220	100 mm	



501-A

Ebat / Size	En / W	Boy / L	Yük / H
Dış / Ext	212	306	126 mm
İç / Int	197	297	112 mm



501-2

Ebat / Size	En / W	Boy / L	Yük / H
Dış / Ext	212	306	126 mm
İç / Int	94	297	112 mm



501-D

Ebat / Size	En / W	Boy / L	Yük / H
Dış / Ext	212	306	126 mm
İç / Int	197	297	55 mm



501-A, 501-D ve 501-2 birbirine monte edilebilir
501-A, 501-D and 501-2 combinations can be created



501-AB

Ebat / Size	En / W	Boy / L	Yük / H
Dış / Ext	212	306	126 mm
İç / Int	197	297	112 mm



510

Ebat / Size	En / W	Boy / L	Yük / H
Dış / Ext	260	340	150 mm
İç / Int	245	331	137 mm



510-2

Ebat / Size	En / W	Boy / L	Yük / H
Dış / Ext	260	340	150 mm
İç / Int	119	331	137 mm



512

Ebat / Size	En / W	Boy / L	Yük / H
Dış / Ext	260	340	150 mm
İç / Int	245	331	65 mm



513

Ebat / Size	En / W	Boy / L	Yük / H
Dış / Ext	260	340	150 mm
İç / Int	245	331	43 mm



510, 510-2 ve 513 birbirine monte edilebilir
510, 510-2 and 513 combinations can be created



>	401-3		
Ebat / Size	En / W	Boy / L	Yük / H
Dış / Ext	360	200	155 mm
İç / Int	110	195	143 mm



>	401-3D		
Ebat / Size	En / W	Boy / L	Yük / H
Dış / Ext	125	200	155 mm
İç / Int	110	195	143 mm



>	401-6		
Ebat / Size	En / W	Boy / L	Yük / H
Dış / Ext	360	200	155 mm
İç / Int	110	195	70 mm



>	401-6D		
Ebat / Size	En / W	Boy / L	Yük / H
Dış / Ext	125	200	155 mm
İç / Int	110	195	70 mm



>	401-9		
Ebat / Size	En / W	Boy / L	Yük / H
Dış / Ext	360	200	155 mm
İç / Int	110	195	44 mm



>	401-9D		
Ebat / Size	En / W	Boy / L	Yük / H
Dış / Ext	125	200	155 mm
İç / Int	110	195	44 mm



>	401-4		
Ebat / Size	En / W	Boy / L	Yük / H
Dış / Ext	360	200	155 mm
İç / Int	170	195	70 mm



401-3, 401-4 ve 401-9 birbirine monte edilebilir.
401-3, 401-4 end 401-9 combinations can be created.

401-3D, 401-6D ve 401-9D birbirine monte edilebilir.
401-3D, 401-6D end 401-9D combinations can be created.

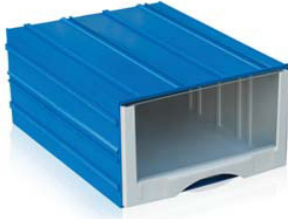

> 450-G				
Ebat / Size	En / W	Boy / L	Yük / H	
Dış / Ext	173	230	110 mm	
İç / Int	160	218	100 mm	

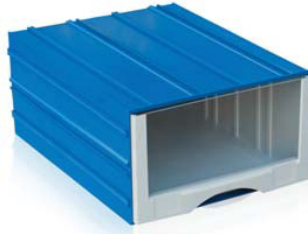

> 501-G				
Ebat / Size	En / W	Boy / L	Yük / H	
Dış / Ext	212	306	126 mm	
İç / Int	193	290	110 mm	

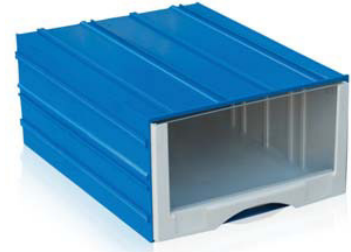

> 511				
Ebat / Size	En / W	Boy / L	Yük / H	
Dış / Ext	260	340	150 mm	
İç / Int	246	325	135 mm	



> 401-G				
Ebat / Size	En / W	Boy / L	Yük / H	
Dış / Ext	120	200	80 mm	
İç / Int	110	190	70 mm	



> 500-G				
Ebat / Size	En / W	Boy / L	Yük / H	
Dış / Ext	140	230	98 mm	
İç / Int	124	217	85 mm	



> 451-G				
Ebat / Size	En / W	Boy / L	Yük / H	
Dış / Ext	173	230	110 mm	
İç / Int	160	218	100 mm	



> MS-1		> MS-1 K	
Ebat / Size	En / W	Boy / L	Yük / H
Dış / Ext	100	80	110 mm
İç / Int	80	70	100 mm



> MS-2		> MS-2 K	
Ebat / Size	En / W	Boy / L	Yük / H
Dış / Ext	120	110	160 mm
İç / Int	100	95	145 mm



> MS-3		> MS-3 K	
Ebat / Size	En / W	Boy / L	Yük / H
Dış / Ext	150	140	205 mm
İç / Int	125	130	187 mm

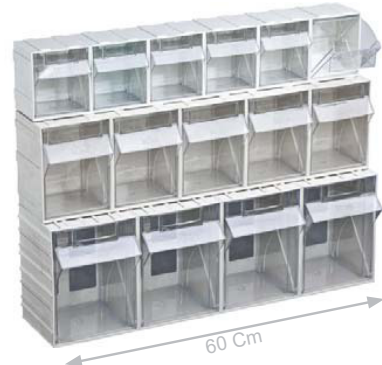



A-400				
Ebat / Size	En / W	Boy / L	Yük / H	
Dış / Ext	310	490	190 mm	

A-350				
Ebat / Size	En / W	Boy / L	Yük / H	
Dış / Ext	260	420	170 mm	

A-300				
Ebat / Size	En / W	Boy / L	Yük / H	
Dış / Ext	215	355	152 mm	

A-250				
Ebat / Size	En / W	Boy / L	Yük / H	
Dış / Ext	172	305	130 mm	



A-200				
Ebat / Size	En / W	Boy / L	Yük / H	
Dış / Ext	150	240	122 mm	

A-175				
Ebat / Size	En / W	Boy / L	Yük / H	
Dış / Ext	125	253	98 mm	

A-150				
Ebat / Size	En / W	Boy / L	Yük / H	
Dış / Ext	125	190	98 mm	

A-100				
Ebat / Size	En / W	Boy / L	Yük / H	
Dış / Ext	102	170	74 mm	



Kod / Code	Separator
B-300	A-300
B-350	A-350
B-400	A-400



Kod / Code	Separator
B-400D	A-400



A-500				
Ebat / Size	En / W	Boy / L	Yük / H	
Dış / Ext	490	390	305 mm	
İç / Inner	430	325	300 mm	

A-530				
Ebat / Size	En / W	Boy / L	Yük / H	
Dış / Ext	600	400	400 mm	
İç / Inner	530	330	395 mm	

A-530-T				
Ebat / Size	En / W	Boy / L	Yük / H	
Dış / Ext	600	400	470 mm	
İç / Inner	530	330	395 mm	

A-500 ve A-530 içiçe geçerek yerden tasarruf sağlar. Aparatları takılı iken üst üste durmaktadır.

It saves space by crossing inside of A-500 and A-530 . Each item stands on top when the appliances are attached.



Yasal Uyarı / Legal Warning

Tasarım tescil no: 2007 06461 A-500 ve A-530 kodlu ürünler; Tasarım Tescil Belgesi ile Koruma altındadır. Kopyalanamaz ve çoğaltılamaz.

Design registration No; 2007 06461 A-500 and A-530 Code Products are protected under regarding designing Registration Document and can not be copied or reproduced .



>	AV-550		
Ebat / Size	En / W	Boy / L	Yük / H
Dış / Ext	340	510	250 mm



>	AV-540		
Ebat / Size	En / W	Boy / L	Yük / H
Dış / Ext	340	510	200 mm



>	AV-520		
Ebat / Size	En / W	Boy / L	Yük / H
Dış / Ext	255	400	200 mm



>	AV-515		
Ebat / Size	En / W	Boy / L	Yük / H
Dış / Ext	255	400	150 mm



>	AV-415		
Ebat / Size	En / W	Boy / L	Yük / H
Dış / Ext	175	400	150 mm



>	AV-315		
Ebat / Size	En / W	Boy / L	Yük / H
Dış / Ext	175	300	150 mm



>	AV-210		
Ebat / Size	En / W	Boy / L	Yük / H
Dış / Ext	130	200	100 mm

Taşıyıcı Sonsuz Sapan



Düz kaldırma kapasitesi (WLL)	Sonsuz Halat Uzunlukları (L1) m					
	2 m	3 m	4 m	5 m	6 m	8 m
1.000 kg	✓	✓	✓	✓	✓	✓
2.000 kg	✓	✓	✓	✓	✓	✓
3.000 kg	✓	✓	✓	✓	✓	✓
4.000 kg	✓	✓	✓	✓	✓	✓
5.000 kg	✓	✓	✓	✓	✓	✓
6.000 kg	✓	✓	✓	✓	✓	✓
8.000 kg	✓	✓	✓	✓	✓	✓
10.000 kg	✓	✓	✓	✓	✓	✓

Taşıyıcı Sapan

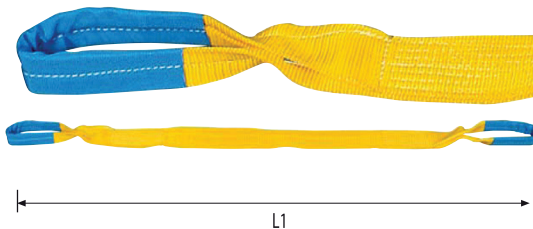

Düz kaldırma kapasitesi (WLL)	Sonsuz Halat Uzunlukları (L1) m					
	2 m	3 m	4 m	5 m	6 m	8 m
1.000 kg	✓	✓	✓	✓	✓	✓
2.000 kg	✓	✓	✓	✓	✓	✓
3.000 kg	✓	✓	✓	✓	✓	✓
4.000 kg	✓	✓	✓	✓	✓	✓
5.000 kg	✓	✓	✓	✓	✓	✓
6.000 kg	✓	✓	✓	✓	✓	✓

Transpalet



Model	TL-DM 20	TL-DF 25	TL-DM 20-80
Tip	Hidrolik Transpalet	Hidrolik Transpalet	Hidrolik Kısa Transpalet (80 cm)
Kaldırma Kapasitesi	kg. 2000	2500	2000 (yük merkezinde)
Maksimum Çatal Yüksekliği	mm 190	195	190
Minimum Çatal Yüksekliği	mm 75	85	75
Yön Tekerleği	mm 160X70	180 x 70	160 x 70
Yük Tekerleği	mm 70X70	80 x 70	70 x 70
Çatal Genişliği	mm 520	520	520
Çatal Uzunluğu	mm 1150	1150	800
Tekerlekler	KIRMIZI POLİÜRETAN	KIRMIZI POLİÜRETAN	KIRMIZI POLİÜRETAN
Transpalet Ağırlığı	kg. 55-60	65 - 70	55 - 60

Terazili Transpalet

Model	TL-BFC 20	TL-BFC 6-II
Tip	Terazili Transpalet	Terazili-Yazıcılı Transpalet
Kaldırma Kapasitesi	kg. 2000	2000
Maksimum Çatal Yüksekliği	mm 205	205
Minimum Çatal Yüksekliği	mm 85	85
Yön Tekerleği	mm 160 x 70	160x70
Yük Tekerleği	mm 70 x 70	70x70
Çatal Genişliği	mm 540	540
Çatal Uzunluğu	mm 1150	1150
Tekerlekler	KIRMIZI POLİÜRETAN	KIRMIZI POLİÜRETAN
Transpalet Ağırlığı	kg. 135	135

Garaj Vinci

Model	SDJ 2
Kaldırma kapasitesi	500-2000
Min.-Maks. Bom uzunluğu	960-1500
Min.-Maks. Bom yüksekliği	350-1840
Net ağırlık	92



Manuel İstifleme



Model	TL-SDJ 1030	TL-CDD15B 25
Kaldırma Kapasitesi	kg. 1000 (yük merkezinde)	1500
Tip	Manuel İstif Makinası - 3000 mm	Yarı manuel İstif Makinası 2500 mm
Minimum Makina Yüksekliği	mm 3000	1840
Minimum Çatal Yüksekliği	mm 90	90
Kaldırma Yüksekliği	mm 550	2500
Yön Tekerleği	mm 1100	180x50
Yük Tekerleği	mm 1655	80x70
Çatal Genişliği	mm 2080	580
Çatal Boyu	mm 860	1070
Akü	volt	24
Ağırlık	kg. 307	660

Yarı Akülü İstifleme



Tek Makaslı Platform



Model	TL-CZ 503	TL-SPS 800	TL-SPB 1000	TL-SP 1500
Tip	Makaslı Yük Platformu	Makaslı Yük Platformu	Makaslı Yük Platformu	Makaslı Yük Platformu
Kaldırma Kapasitesi	kg. 500	800 (yük merkezinde)	1000 (yük merkezinde)	1500
Maksimum Tabla Yüksekliği	mm 920	1500		1000
Minimum Tabla Yüksekliği	mm 320	475	1000	420
Tabla Ölçüleri	mm 900x60x35	1220x610x60	1016x515x60	1220x610x60
Platform Ağırlığı	kg. 75	172	115	135

Çift Makaslı Platform



Model	TL-SP 350	TL-SPF 680	TL-SPS 800
Tip	Makaslı Yük Platformu	Makaslı Yük Platformu	Makaslı Yük Platformu
Kaldırma Kapasitesi	kg. 350 (yük merkezinde)	680	800 (yük merkezinde)
Maksimum Tabla Yüksekliği	mm 1300	1500	1500
Minimum Tabla Yüksekliği	mm 350	475	475
Tabla Ölçüleri	mm 910x500x52	1220x610x55	1220x610x60
Platform Ağırlığı	kg. 110	185	172

Makaslı Transpalet



Model	TL-JF 7
Tip	Makaslı Transpalet
Kaldırma Kapasitesi	kg. 1000 (yük merkezinde)
Maksimum Çatal Yüksekliği	mm 810
Minimum Çatal Yüksekliği	mm 85
Yön Tekerleği	mm 180x50
Yük Tekerleği	mm 74x50
Çatal Genişliği	mm 550
Çatal Uzunluğu	mm 1220



Zincirli Caraskal



Kapasite (ton)	S.W.L. Güvenli Çalışma Yüğü (kg)	Test Yüğü (ton)	Standart Kaldırma Yüksekliği (m)	Caraskal Yüksekliği (mm)	Net Ağırlık (kg)
0.5	500	0.75	2.5	305	10.3
1	1000	1.50	2.5	340	11.1
1.5	1500	2.25	2.5	385	15.5
2	2000	3.0	3.0	420	19.7
3	3000	4.50	3.0	465	23.4
3	3000	4.50	3.0	550	30.7
5	5000	7.5	3.0	575	37.8
10	10000	15	3.0	660	69.3

Elektrikli Vinç

Model	W 200-400	W 500-1000
Kaldırma kapasitesi / Tek-Çift hat	200 - 400	500 - 1000
Kaldırma yüksekliği / Tek-Çift hat	12/ 6	12 / 6
Koruma sınıfı	IP 54	IP 54
Kaldırma hızı / Tek-Çift hat	10/ 5	10/ 5
Halat uzunluğu	12	12
Halat çapı	3.6	6
Motor gücü	930	1650
Voltaj / Tek-Çift hat	230/ 50	230/ 50

Tezgah Tamponu

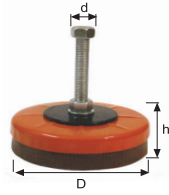

MODEL	D	d	h	Ayar Mesafesi	Taşıma Kg - Adet
ES 1	80	M12 x 1,25	45	12	500
ES 2	120	M16 x 1,5	45	15	1000
ES 3	160	M16 x 1,5	54	15	2000
ES 4	160	M20 x 1,5	55	15	4000
ES 5	200	M20 x 2,5	55	25	5000
ES 6	200	M24 x 3,0	55	25	6000
ES 7	240	M20 x 2,5	65	25	7000

Kauçuk Takoz



MODEL	WxL (mm)	H (mm)	Taşıma
EK100 20	100x100	20	500
EK100 30	100x100	30	500
EK120 20	120x120	20	750
EK120 30	120x120	30	750
EK150 20	150x150	20	1,250
EK150 30	150x150	30	1,250
EK200 20	200x200	20	1,250
EK125 20	125x200	20	1,250
EK125 30	125x200	30	1,250
EK300 13	300x300	13	4,000
EK300 20	300x300	20	4,000
EK500 20	300x500	20	6,000

Bor Yağı Hortumu



Kod	Ağız	h	Ayar Mesafesi
ESK	Yuvarlak	300	1/4
ESB	Yuvarlak	400	3/8
ESK G	Geniş - Ördek	300	1/4
ESB G	Geniş - Ördek	400	3/8
ESB 1/2	Yuvarlak	400	1/2
ESB 1/2G	Geniş - Ördek	400	1/2
Musluk	Hortum fiyatına eklenir		

Kollu Gres Pompası



İnce Yağ Pompası Dişi - Erkek



Freze Çektirme Mili

ISO 40 M 16



ISO 30 M 12



Freze Talaş Koruma Körükleri

Ön Körük



450 x 500 cm

Arka Körük



500 x 700 cm

Gres Kovası



Varil Pompası



Miknatısların Kullanım Alanları

- Kil temizleme (Demirli minerallerin ayrımı.)
- Cam kumu temizleme (Demir minerallerinin ayrımı.)
- Manyezit zenginleştirme (Serpatin ve demirli bileşiklerin ayrımı)
- Artıklardan metal kazanımı
- Döküm kumlarının temizlenmesi
- Refrakter hammaddelerin işlenmesinde
- Bor zenginleştirme (Demirli içerikler, kil, arsenik ve mika uzaklaştırılması)
- Kromit zenginleştirme
- Magnetik zenginleştirme
- Atıklardan metal ayrımı
- Ahşap, plastik, gıda v.b. sektörlerde istenmeyen metallerin ayrılmasında
- Sıvılar içindeki demir bileşiklerinin ayrılmasında
- Ağır ortamlarda oluşturulan ağır ortamın geri kazanılmasında
- Dökümden gelen metalin ayrımında
- Yüksek alan şiddetli magnetik çubuklar, seramik, cam, gıda, plastik, madeni yağ, boyalar, kuru ve sıvı ortamlarda demir ve diğer magnetik metallerin tutulmasını sağlar.



HB

• 1. Kalite Nikel Kaplaması Karamaz

• Tuzlu Su Testine Tabi Tutulmuştur

Yuvarlak Neodyum				Kare Neodyum				
Çap (mm)	Kalınlık (mm)	9	1.5	15	10	Kalınlık (mm)	En (mm)	Boy (mm)
2	3	9	2	17	3	1	10	10
2	4	9	3	18	3	1	10	15
3	3	10	1.5	18	4	1	10	20
4	4	10	2	18	10	2	15	15
4	6	10	3	20	2	2	20	20
5	5	10	5	20	3	2	10	30
5	10	10	10	20	5	2	8	20
5	15	10	1	20	6	3	10	20
6	1.5	11	2	20	10	5	5	5
6	3	11	2	22	2	5	15	15
6	10	12	3	22	3	5	20	20
7	2	12	1.5	22	10	10	10	10
8	2	14	1.5	25	5	10	25	40
8	3	15	2	35	5			
8	4	15	3	40	5			
8	5	15	10	50	10			

